

Nice Wide, solid and essential



EASY TO INSTALL

Large front door for quick and easy access. The bar can be assembled either on the right or left. Easily removable reinforced gear motor support.



VANDAL-PROOF SAFETY

Photocells integrated inside the barrier body, minimum visual impact and maximum protection.



PRACTICAL TO MAINTAIN

The built-in control unit can be removed to simplify wiring and maintenance. A backup battery installed inside the control unit prevents blackout problems.

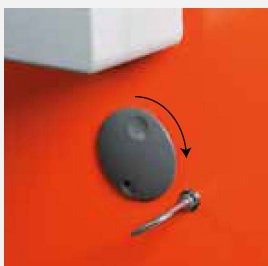

COMFORTABLE AND INTUITIVE RELEASE

Easy release of barrier system thanks to a triangular key.

Removable cover for easy access to the inside parts

Elliptical section bar with high wind-gust resistance

Protected release against the weather

Cataphoresis treated and painted or stainless steel case

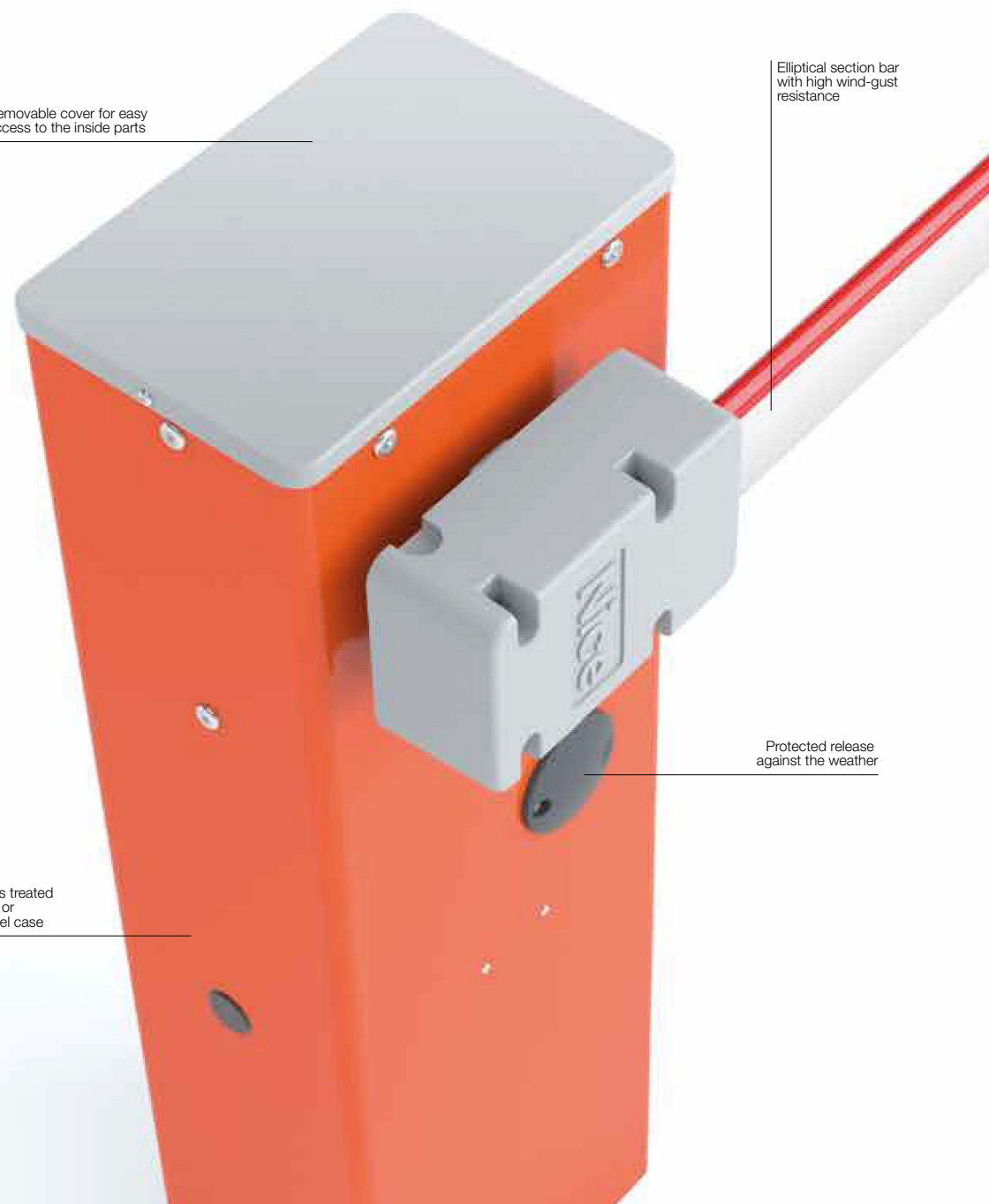

Selection guide, composition of bars and accessories

Bars and accessories are not included in the gear motor's code

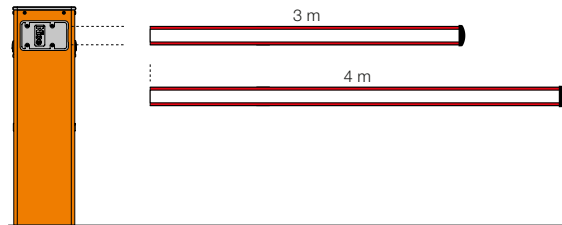

280 mm

WIDES

With 3 m bar

Designed for:
protective rubber trim,
indicator lights,
pivot joint,
rack (1 pcs)

With 4 m bar

Designed for:
protective rubber trim,
indicator lights,
pivot joint

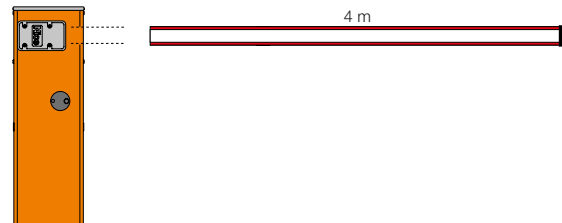

320 mm

WIDEM

With 4 m bar

Designed for:
protective rubber trim,
indicator lights,
pivot joint,
pivot joint,
rack (2 pcs),
mobile stand

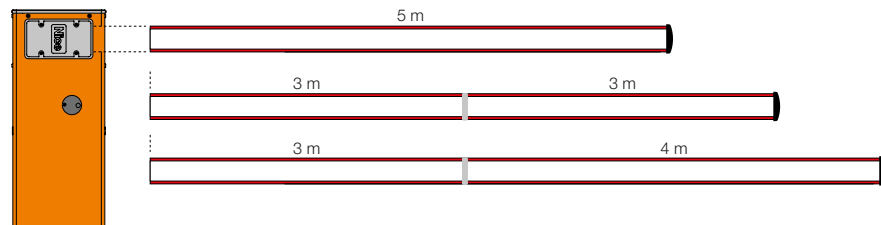

420 mm

WIDEL

With 5 m bar

Designed for:
protective rubber trim,
indicator lights,
rack (2 pcs),
mobile stand

With 6 m bar (3+3 m)*

Designed for:
protective rubber trim,
indicator lights,
rack (2 pcs),
mobile stand

With 7 m bar (3+4 m)*

Designed for:
protective rubber trim,
indicator lights

* Use XBA9 joint to assemble bars

For swing gates

For sliding gates

Barrier gates
operator systems

For garage
and industrial doors

Control systems
and accessories

Compatibility table
and alphabetical index

Wide System

Electromechanical road barrier system for control of road access

24 Vdc gear motor, with built-in control unit, adjustable speed and anti-crush safety function.

Two types of case available, galvanized steel or stainless steel (AISI 304) in **three sizes from 3 to 7 metres long**.

More comfort and safety in programming and maintenance phases: The same built-in control unit is used on all versions, and is installed in the bottom part of the barrier body.

Large front door for quick and easy access.

Easily-removable reinforced gear motor support.

Maximum safety: when both opening and closing; barrier body supports on the inside for minimum visual impact.

Electronically-adjustable speed from 3.5" (Wide M) to 5" (Wide L) for fast opening.

Sturdiness, reliability and easy installation: elliptical section bar for lighter weight and higher wind-gust resistance; special profile for fast assembly of the accessories.

Optional pivot joint to protect the barrier in the event of collision.

The bar can be assembled either on the right or left.

Easy to balance, thanks to practical spring tension adjustment.

No black out: operation is guaranteed in the event of power outages by the PS234 backup battery installed inside the control unit.

Release with triangular key protected against the weather.

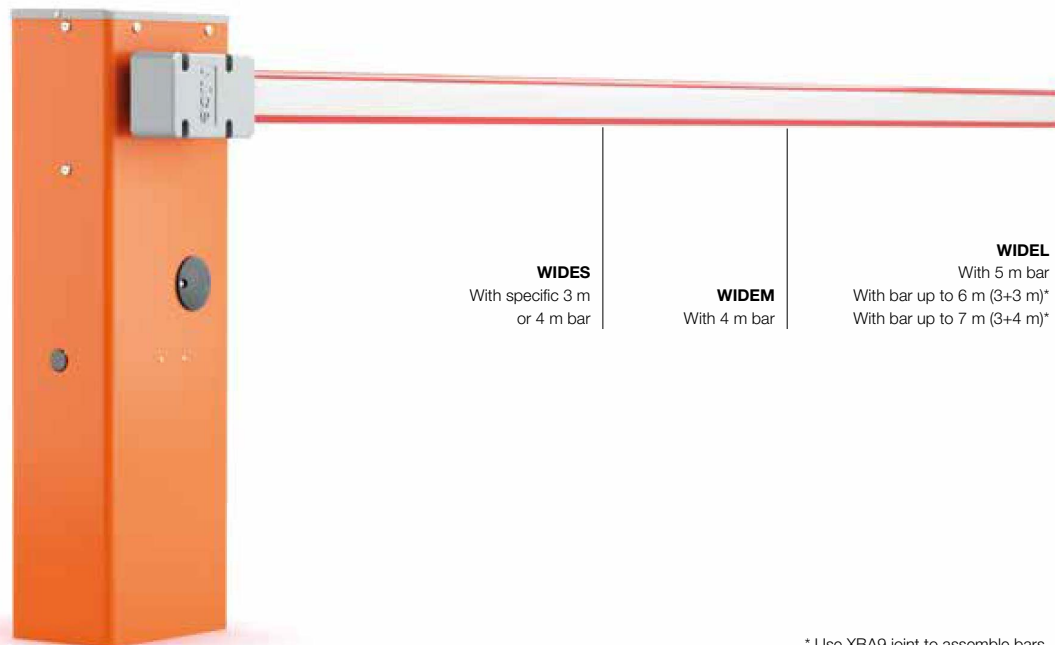

WIDES
With specific 3 m
or 4 m bar

WIDEM
With 4 m bar

WIDEL
With 5 m bar
With bar up to 6 m (3+3 m)*
With bar up to 7 m (3+4 m)*

* Use XBA9 joint to assemble bars.

Nice **BiDirectional products** indicate the status of the automations and confirm correct reception of the command.

Discover the complete range of BiDirectional products on page 176.

Yubii is the new Nice ecosystem that connects all the automations in the home.

Discover all the benefits of the Yubii system on page 168.

DIMENSIONS

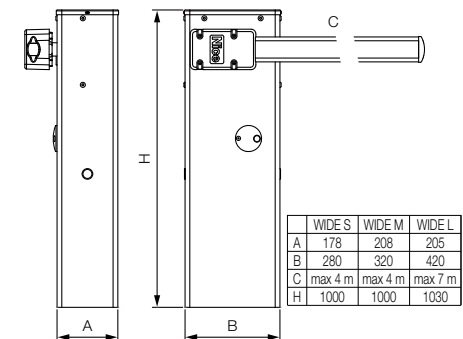

COMMON ACCESSORIES



CORE
Nice Wi-Fi-Radio Gateway.
Pc./Pack 1



IBT4N
Interface for connecting the O-View programming unit.
Pc./Pack 1



BIDI-ZWAVE
Plug-in communication interface between Z-Wave™ gateways and Nice motors.
Pc./Pack 1



IT4WIFI
Smart Wi-fi interface to manage gates and garage doors by smartphone (*).
Pc./Pack 1



WIA20
Spare control unit.
Pc./Pack 1



PS324
24 V battery with integrated battery charger.
Pc./Pack 1



XBA13
Rubber impact protection strip. Length 1 m.
Pc./Pack 9



WA10
Red adhesive reflector strips.
Pc./Pack 24



WA11
Adjustable stand for bars.
Pc./Pack 1



WA13
Aluminium rack up to 2 m.
Pc./Pack 1

IN ORDER TO HAVE A FULLY FUNCTIONAL BARRIER GATE OPERATOR SYSTEM:

1. CHOOSE THE GEAR MOTOR

2. SELECT THE BAR

3. COMPLETE THE SYSTEM WITH THE OPTIONAL ACCESSORIES

TECHNICAL SPECIFICATIONS

With bar up to 4 m, irreversible 230 Vac, irreversible 230 Vac, 24 Vdc motor, with foundation plate:

Code	Description
WIDES	With painted galvanised steel case
WIDESI	With stainless steel case
WIDEM	With painted galvanised steel case
WIDEMI	With stainless steel case

With bar up to 7 m, irreversible 230 Vac, irreversible 230 Vac, 24 Vdc motor, with foundation plate:

Code	Description
WIDEL	With painted galvanised steel case
WIDELI	With stainless steel case

Code	WIDES	WIDESI	WIDEM	WIDEMI	WIDEL	WIDELI
ELECTRICAL DATA						
Power supply (Vac 50/60 Hz)				230		
Power supply (Vdc)				24		
Absorption (A)	1		1,1		0,6	
Power (W)	300			360		
PERFORMANCE DATA						
Speed (s)	4		3,5		5	
Torque (Nm)	100		140		200	
Work cycle (cycles/hour)	100		300		200	
DIMENSIONAL AND GENERAL DATA						
Protection level (IP)				54		
Working temp. (°C Min/Max)				-20 ÷ +50		
Dimensions (mm)	280x178x1000 h		320x205x1000 h		420x205x1030 h	
Weight (kg)	40		46		54	

COMPATIBILITY TABLE WITH CONTROL SYSTEMS AND ACCESSORIES

Code	receiver			transmitter							photocells								flashing light				
	Built-in*	OXIBD	OXILR	ERA INTI	ERA ONE	ERA ONE BD	ERA ONE LR	ERA FLOR	NICEWAY	EPS	EPW	EPL	EPSB	EPWB	EPLB	EPWOR	F210	FT210	F210B	FT210B	ELAC	ELDC	WLT
WIDES / WIDESI	•	•	•	•	•	•	•	•	•	•	•	•	•	•	•	•	•	•	•	•	•	•	•
WIDEM / WIDEMI	•	•	•	•	•	•	•	•	•	•	•	•	•	•	•	•	•	•	•	•	•	•	•
WIDEL / WIDELI	•	•	•	•	•	•	•	•	•	•	•	•	•	•	•	•	•	•	•	•	•	•	•

* Radio receiver incompatible with Opera system

For swing gates

For sliding gates

Barrier gates operator systems

For garage and industrial doors

Control systems and accessories

Compatibility table and alphabetical index

Accessories Wide

BARS FOR WIDE S



XBA19
White paint-finished aluminium bar 45x58x4270 mm.
Pc./Pack 1

ACCESSORIES FOR WIDE S



XBA4
Indicator lights for click fixture on upper or lower side of bar. Length 4 m.
Pc./Pack 1



WIA10
Pivot joint.
Pc./Pack 1



SIA1
Storage base with clamps.
Pc./Pack 1

BARS FOR WIDE M



XBA19
White paint-finished aluminium bar 45x58x4270 mm.
Pc./Pack 1

ACCESSORIES FOR WIDE M



XBA4
Indicator lights for click fixture on upper or lower side of bar. Length 4 m.
Pc./Pack 1



WIA10
Pivot joint.
Pc./Pack 1



SIA1
Storage base with clamps.
Pc./Pack 1



WA12
Mobile stand for bars - new fully reinforced version.
Pc./Pack 1



WIA11
Joint for bar for Wide M.
Pc./Pack 1

BARS FOR WIDE L



XBA15
White paint-finished aluminium bar 69x92x3150 mm.

Pc./Pack 1



XBA14
White paint-finished aluminium bar 69x92x4150 mm.

Pc./Pack 1



XBA5
White paint-finished aluminium bar 69x92x5150 mm.

Pc./Pack 1

ACCESSORIES FOR WIDE L



XBA9
Expansion joint.
Pc./Pack 1



XBA6
Indicator lights for click fixture on upper or lower side of bar. Length 6 m.
Pc./Pack 1



XBA18
Indicator lights for click fixture on upper or lower side of bar. Length 8 m.
Pc./Pack 1



SIA2
Anchorage base with clamps.
Pc./Pack 1



WA12
Mobile stand for bars - new fully reinforced version.
Pc./Pack 1